

Type II Vipros 358 King with Fanuc 18P Control Layout Drawings



Amada America Inc.
7025 Firestone Blvd.
Buena Park CA. 90621
Phone: (714) 739 2111
Fax.: (714) 739 4099
Email info@amada.com

Warning

- ❑ Qualified personnel must complete all work.
- ❑ Do not apply power to the Type II Vipros 358 King until an A.E.S.I. (Amada Engineering and Service Incorporated) Engineer is present and has instructed you to do so.
- ❑ Not all information required to install the Type II Vipros 358 King is included with this document. Specific details for proper installation are found in the document *Type II Vipros 358 King with Fanuc 18P User Pre-installation Guide* available at the Amada America Internet web site at <http://www.amada.com/>.
- ❑ Considerable effort has been made to ensure that this manual is free of inaccuracies and omissions. However, as we are constantly improving our product, some of the data contained herein may be out of date. Please check our Internet site, <http://www.amada.com/>, for the latest release of this document.

Contents

Planning the Location of the Type II Vipros 358 King4
Plan View - Type II Vipros 358 King5
Plan View - Type II Vipros 358 King (shown with optional standard conveyors).....6
Plan View - Type II Vipros 358 King (shown with optional standard conveyors and MP1225 Loader)7
End View - Type II Vipros 358 King8
Elevation View - Type II Vipros 358 King9
Chiller Placement.....10

Planning the Location of the Type II Vipros 358 King

The following diagrams provide the details for positioning the Type II Vipros 358 King.

- No obstacles are allowed in the worksheet travel area and the ceiling must be at least 40" above the Type II Vipros 358 King.
- All of the recommended maintenance areas should be used, but at a minimum the doors of the NC unit must be able to be opened. Any reduction of the listed maintenance areas may increase time and expense of installation and maintenance.
- The Type II Vipros 358 King machine and control must be protected from direct sunlight or other heat sources. Direct exposure to direct heating sources such as infrared heaters have been shown to affect punch and die alignment.
- The positioning of the SBC EX5.5 Chiller is very flexible.

Plan View - Type II Vipros 358 King

Electrical Requirements	
E1	Vipros 358 King Type II 230 / 460 / 3 / 60 ±10% 28 kVA 70 amps @ 230 / 3 / 60 VAC 35 amps @ 460 / 3 / 60 VAC
E2	SBC EX5.5 Chiller 230 or 460 / 3 / 60 ±10% 15 kVA 19 amps @ 460 / 3 / 60 VAC 37 amps @ 230 / 3 / 60 VAC
Compressed Air Requirements	
A1	Vipros 358 King Type II 80 psi @ 8.8 ft ³ /min.
	

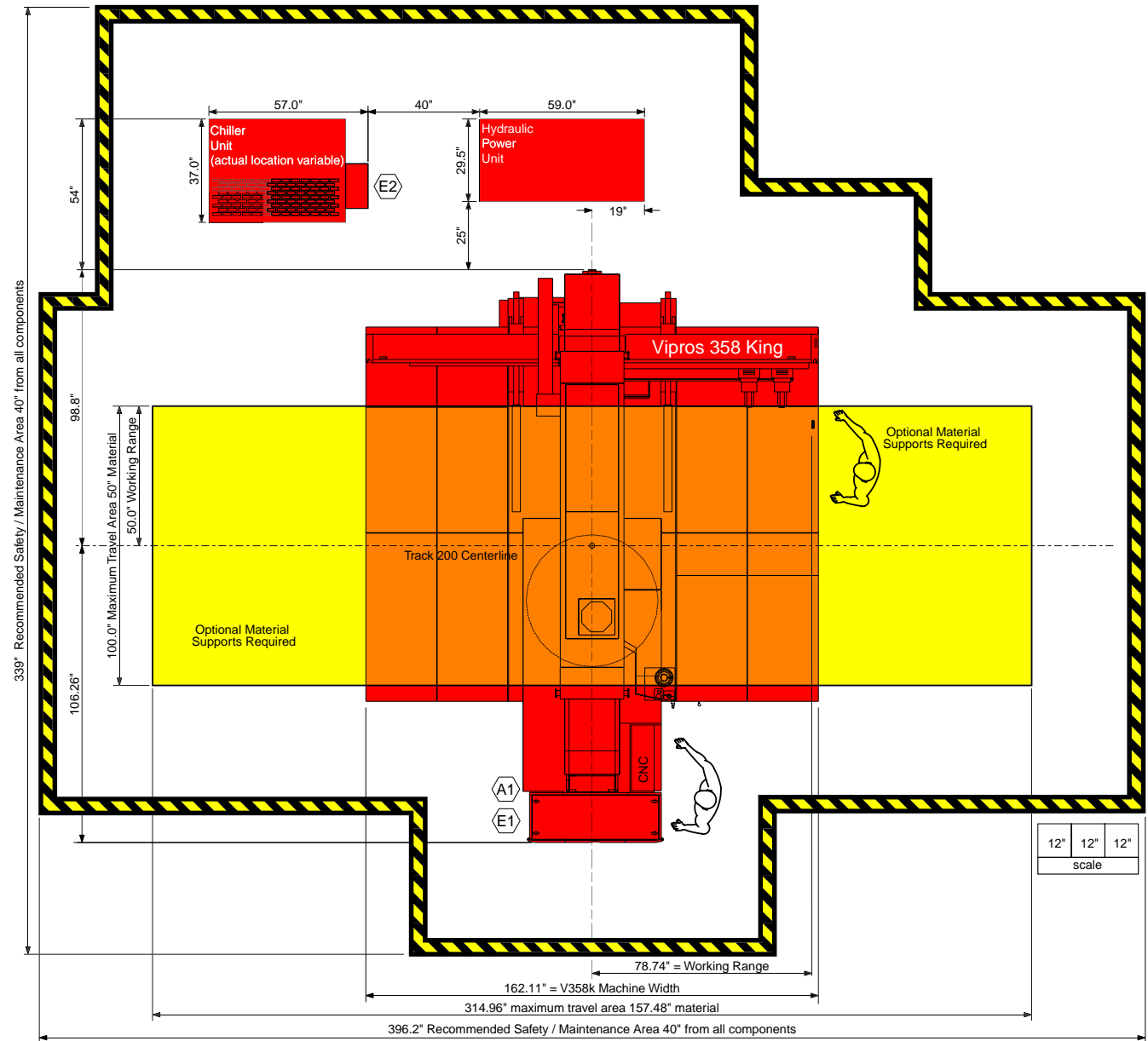

Plan View - Type II Vipros 358 King (shown with optional standard conveyors)

Electrical Requirements	
E1	Vipros 358 King Type II 230 / 460 / 3 / 60 ±10% 28 kVA 70 amps @ 230 / 3 / 60 VAC 35 amps @ 460 / 3 / 60 VAC
E2	SBC EX5.5 Chiller 230 or 460 / 3 / 60 ±10% 15 kVA 19 amps @ 460 / 3 / 60 VAC 37 amps @ 230 / 3 / 60 VAC
E3	V358 Standard Conveyor 1 208 - 230 / 460 / 3 / 60 ±10% .8 kVA 2.1 amps @ 208 / 3 / 60 VAC 2.0 amps @ 230 / 3 / 60 VAC 1.0 amps @ 460 / 3 / 60 VAC
E4	V358 Standard Conveyor 2 208 - 230 / 460 / 3 / 60 ±10% .8 kVA 2.1 amps @ 208 / 3 / 60 VAC 2.0 amps @ 230 / 3 / 60 VAC 1.0 amps @ 460 / 3 / 60 VAC
Compressed Air Requirements	
A1	Vipros 358 King Type II 80 psi @ 8.8 ft ³ /min.
Operator Control Station 	

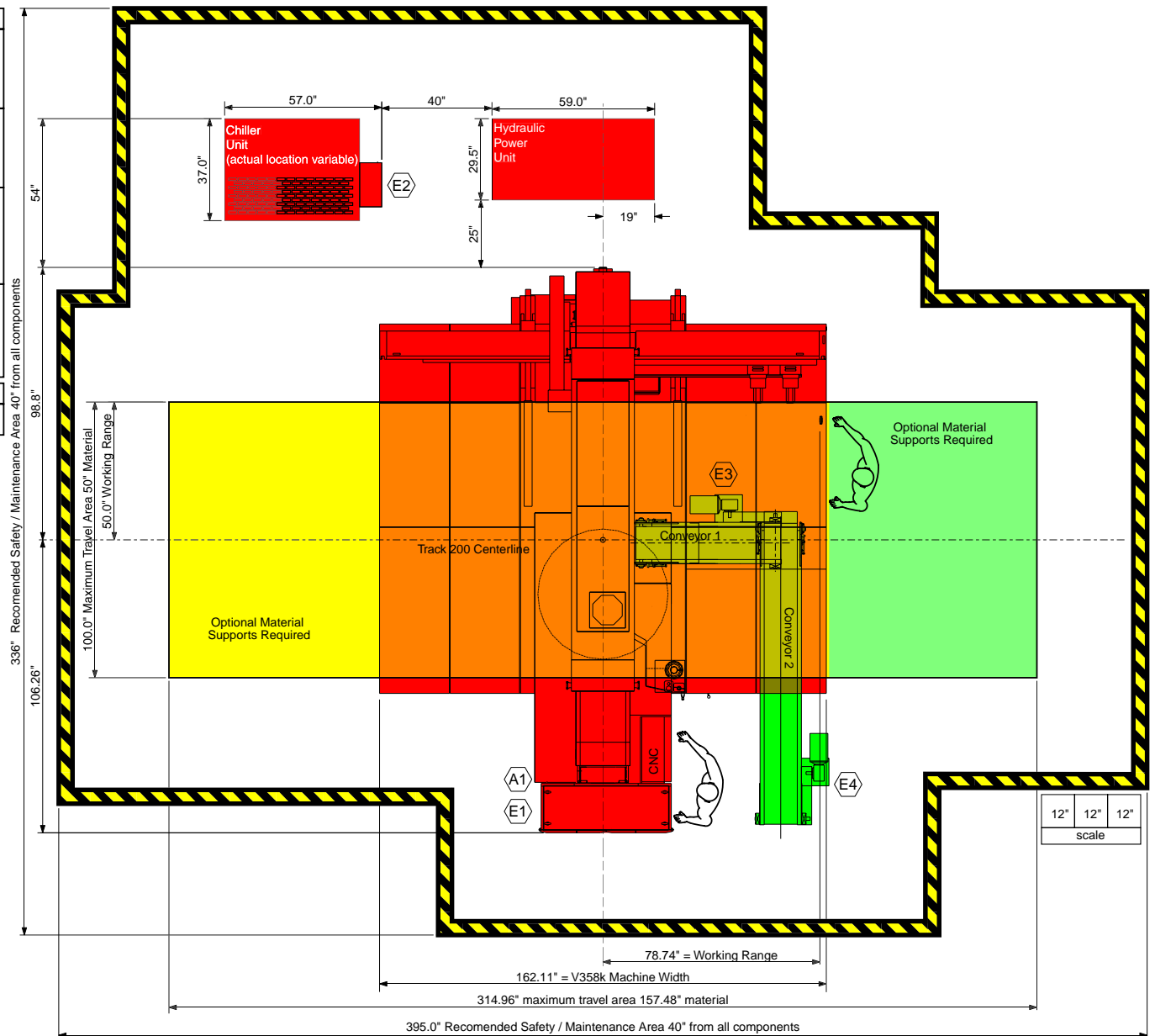

12" 12" 12"
scale

Plan View - Type II Vipros 358 King (shown with optional standard conveyors and MP1225 Loader)

Electrical Requirements	
(E1) Vipros 358 King Type II	230 / 460 / 3 / 60 ±10% 28 kVA 70 amps @ 230 / 3 / 60 VAC 35 amps @ 460 / 3 / 60 VAC
(E2) SBC EX5.5 Chiller	230 or 460 / 3 / 60 ±10% 15 kVA 19 amps @ 460 / 3 / 60 VAC 37 amps @ 230 / 3 / 60 VAC
(E3) V358 Standard Conveyor 1	208 - 230 / 460 / 3 / 60 ±10% .8 kVA 2.1 amps @ 208 / 3 / 60 VAC 2.0 amps @ 230 / 3 / 60 VAC 1.0 amps @ 460 / 3 / 60 VAC
(E4) V358 Standard Conveyor 2	208 - 230 / 460 / 3 / 60 ±10% .8 kVA 2.1 amps @ 208 / 3 / 60 VAC 2.0 amps @ 230 / 3 / 60 VAC 1.0 amps @ 460 / 3 / 60 VAC
(E5) MP1225 Loader	200 / 3 / 60 ±10%, 10 Kva To operate at 230 / 460 VAC a step up transformer is required with the following service is required 29 amps @ 200 / 3 / 60 VAC 26 amps @ 230 / 3 / 60 VAC 13 amps @ 460 / 3 / 60 VAC
Compressed Air Requirements	
(A1) Vipros 358 King Type II	80 psi @ 8.8 ft ³ /min.
(A2) MP1225 Loader	75 psi @ 31.8 ft ³ /min.
Operator Control Station	
	

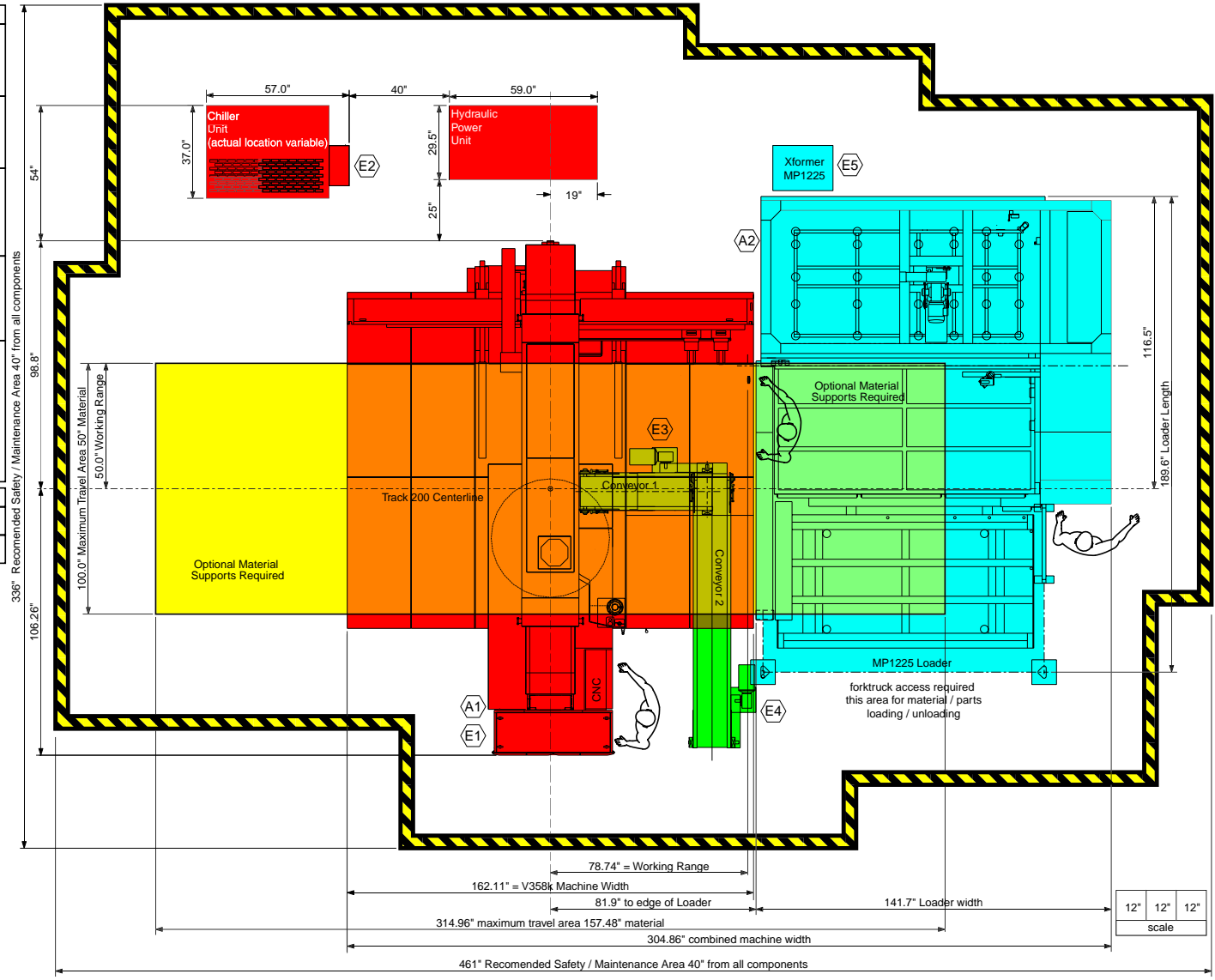

End View - Type II Vipros 358 King

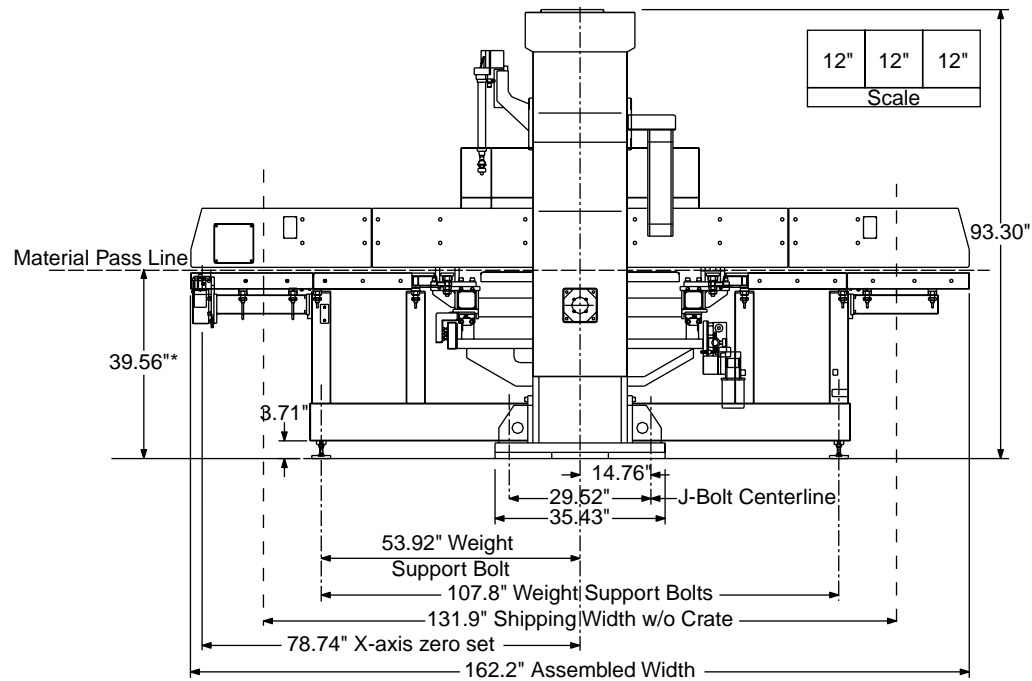

*Material Pass Line may increase with installation of available options

Elevation View - Type II Vipros 358 King

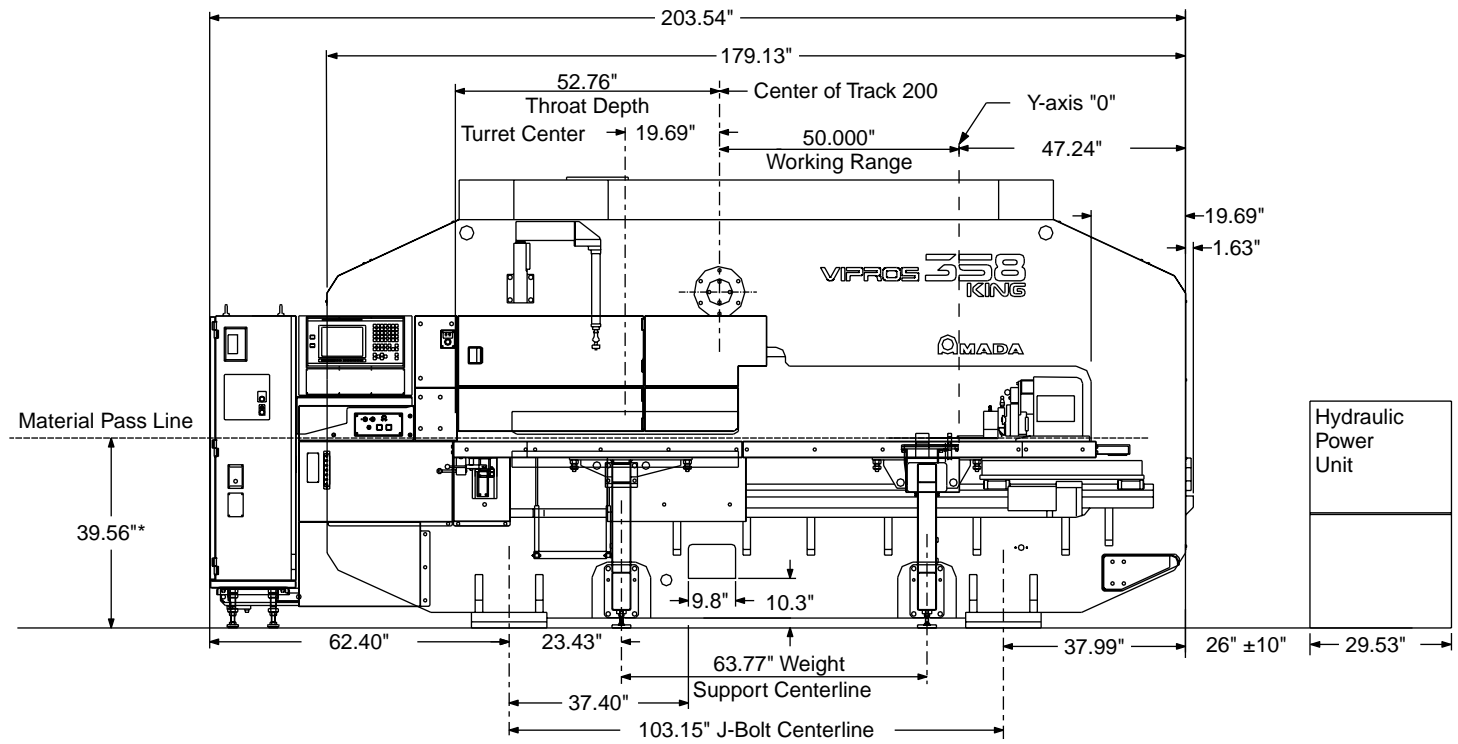

*Material Pass Line may increase with installation of available options

Chiller Placement

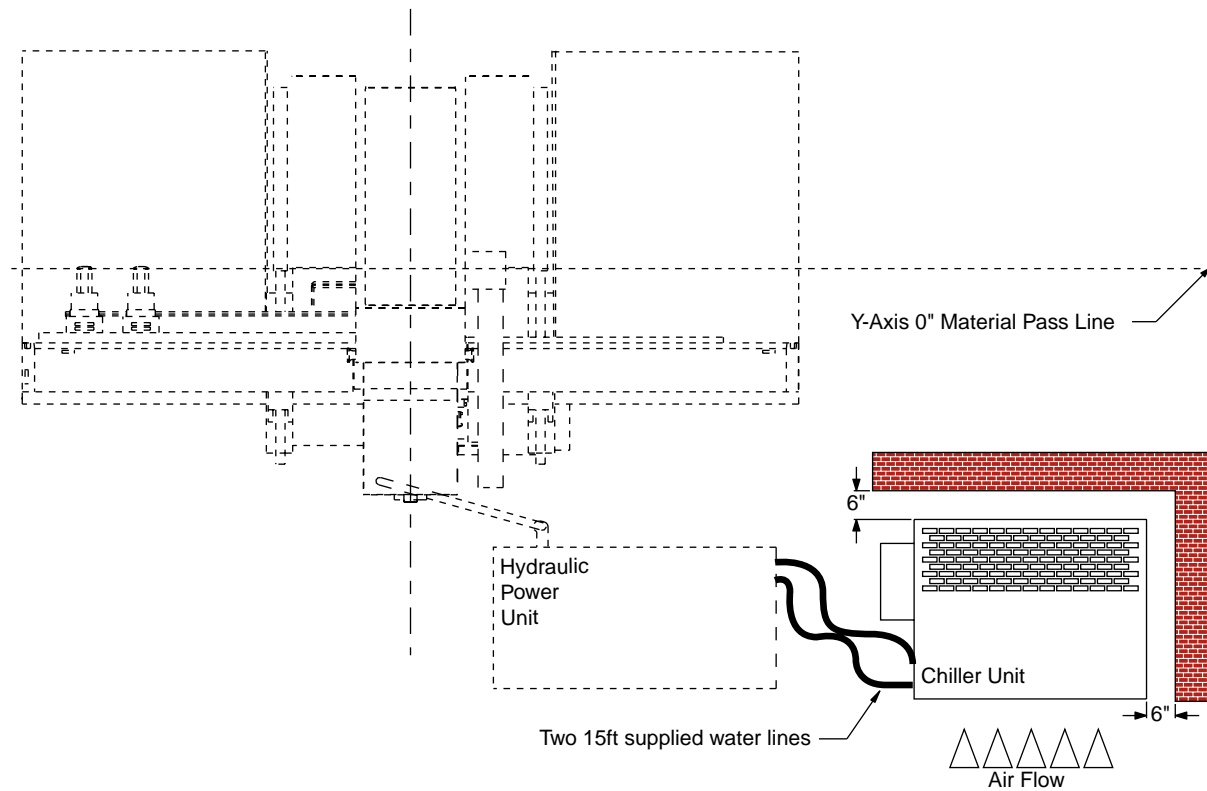

Under normal operating conditions the Chiller may be placed against walls as shown.
 For maintenance purposes access to all sides may be required.
 60" overhead clearance required.
 Chiller may be located up to 50ft from Hydraulic Unit.
 Chiller is not designed for outdoor placement.